



## VRGT Waterstop Submittal Package

Project Name: \_\_\_\_\_

Architect: \_\_\_\_\_

Engineer: \_\_\_\_\_

General Contractor: \_\_\_\_\_

Sub Contractor: \_\_\_\_\_

Specification Section: \_\_\_\_\_

Profile Type: \_\_\_\_\_

Profile Catalog #: \_\_\_\_\_

### Table of Contents:

- Factory Made
- URGT Waterstop Compound Technical Data
- Waterstop Installation Procedure
- Common Factory Made Intersection
- VRGT Waterstop Splicing Guidelines

\*\*\*\*\*

INSERT DRAWING HERE  
(PAGE LEFT BLANK INTENTIONALLY)

\*\*\*\*\*

\*\*\*\*\*

INSERT SPEC SHEET HERE  
(PAGE LEFT BLANK INTENTIONALLY)

\*\*\*\*\*



## Technical Data Sheet TPER Waterstop Compound

<b>Typical Properties</b>	<b>Minimum Value</b>	<b>ASTM Method</b>
Hardness, Shore A ( $\pm 3$ )	90	D-2240
Tensile Strength, lb/in (MPa)	2300 (15.9)	D-412
Elongation, %	530	D-412
Brittle Point, °F (°C)	-65(-54)	D-746
Specific Gravity, g/cm <sup>3</sup>	0.96	D-792
100% Modulus, psi (MPa)	1000(6.9)	D-638
Ozone Resistance	500pphm Passed	D-1171

**IMPORTANT:** The technical data herein is believed to be accurate. It is offered for your consideration, investigation and verification. Buyer assumes all risk of use, storage and handling of the product. NO WARRANTY, EXPRESS OR IMPLIED, IS MADE INCLUDING, BUT NOT LIMITED TO, IMPLIED WARRANTIES OR MECHANABILITY AND FITNESS FOR A PARTICULAR PURPOSE. Nothing contained herein shall be construed as a license to operate under or recommendation to infringe any patents.

## General TPER Waterstop Installation Procedure

### Preparation:

During progress of work all waterstop should be protected from damage and should be free of oil, dirt and concrete spatter. Waterstop coils should be uncoiled several days before installation to insure ease of installation and fabrication. Be sure steel reinforcing bars do not interfere with proper positioning of waterstop.

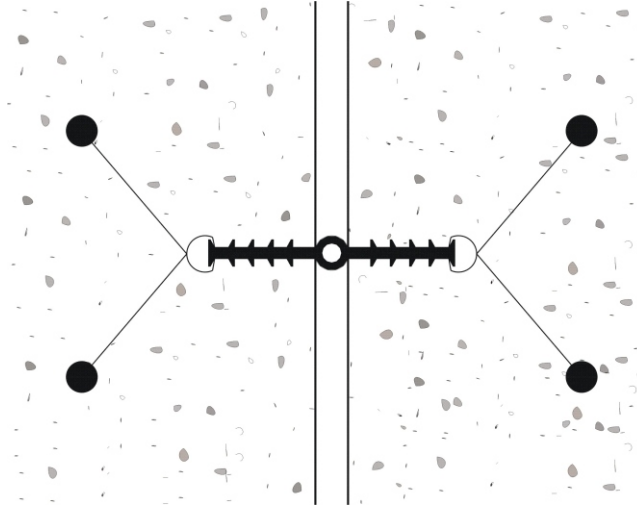

### Location & Placement of Waterstop:

The location and embedment of the waterstop should be determined by the use of the construction drawings of the project. Approximately one half of the width of the waterstop embedded in the concrete on each side of the joint. All waterstops shall be sufficiently held in place to insure that they are correctly positioned to form a continuous watertight diaphragm in the joint unless otherwise shown. The method used to fasten the waterstop may be as follows:

- through a slot in the keyway
- held in place by split bulkheads
- hog ring and wire tie to reinforcing bar every 12 inches. Always secure hog ring or wire between the last rib and the end of the waterstop. Hog ring shall not penetrate the waterstop.
- BoMetals, Inc can provide hog rings 12” on center up request.

### Placement of Concrete:

Care should be taken during concrete placement to prevent excessive movement of the waterstop to insure against displacement. Always thoroughly and systematically vibrate concrete around the waterstop to avoid air entrapment and to provide a positive contact between the waterstop and concrete. On the second pour, sweep horizontal joints to insure there is no foreign matter to interfere with positive contact between the waterstop and the concrete.

## Common Intersections

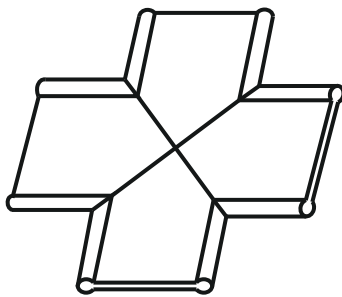

Flat Cross

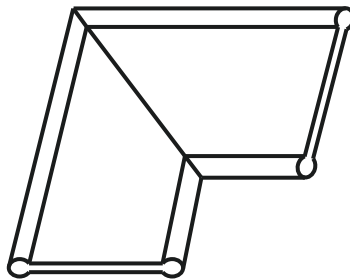

Flat Ell

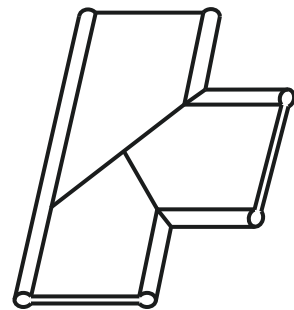

Flat Tee

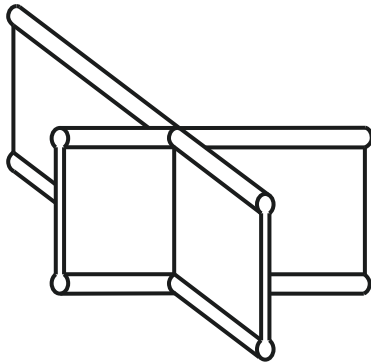

Vertical Cross

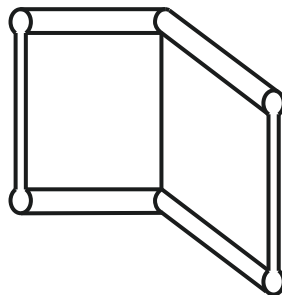

Vertical Ell

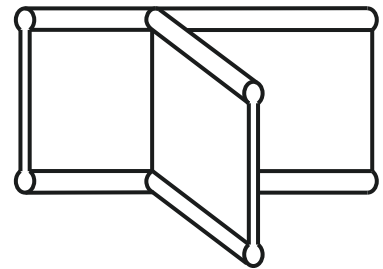

Vertical Tee



## Waterstop Splicing Field Guide

Following is the proper procedure for field splicing of nonmetallic waterstop. BoMetals highly recommends that all intersections be factory fabricated and that only straight butt joints be attempted in the field.

### Equipment:

You will need a Teflon covered waterstop splicing iron (part # SI-414 Splicing Iron), a sturdy heat resistant work surface (part # ST-10 Field Splicing Machine), access to 115 VAC power, circular saw with carbide tipped blade, framing square, and miscellaneous jigs and fixtures to aid splicing.

**Caution: When splicing PVC waterstop, inhalation of the fumes may be harmful to your health. Splicing should be done in only in well-ventilated areas.**

### Splicing:

1. Preheat splicing iron to 350°F-380°F for PVC or 390°F-410°F for TPER. Preheat iron for at least 30 minutes to assure even temperature.
2. Layout and cut the ends square using carbide tipped circular saw. Ends must be cut square and cleaned of debris to assure proper alignment and bond strength.
3. Dry Fit joint to check fin and bulb alignment before welding. Repeat step 2 if necessary.
4. Place iron between butt ends of the waterstop. Apply light and even pressure to the waterstop in the direction of the iron. Insure that the butt ends are heated evenly across the waterstop profile. A slot in the work surface would be helpful in allowing the iron to protrude below the bottom of the waterstop profile. Keep the waterstop in place and pressure applied until a 3/16" bead forms around the entire outside edge of the waterstop profile on both butt ends. Caution: Iron and plastics are hot. Take precaution to avoid burns. Do not hold the waterstop in contact with the iron so long that it begins to darken and burn. Burnt material will contaminate the joint and cause possible joint failure.
5. Remove iron and **immediately** join the butt ends together with light and even pressure. Care must be taken to align the profiles and maintain the continuity of the bulbs and ribs. Hold in place for approximately 3 minutes or until the bond is cooled enough to hold together. Do not bend, stretch, or stress the joint for approximately 10 minutes or until it has cooled to room temperature. Failure to join the ends quickly or premature stress can result in a poor weld and joint failure.
6. Wipe the iron clean with a clean dry cloth to remove any molten material. Burnt material will contaminate future joints and cause possible failures. Caution: Iron and plastics are hot. Take precaution to avoid burns.
7. Contact BoMetals Inc. 1-800-862-4835 with any questions or for assistance.